

ref.	Part Number	Description	std	opt
1	H 28 01 01 610	SINGLE RAIL SINGLE LIFELINE BOW PULPIT		1
	H 28 01 05 610	DOUBLE RAIL DOUBLE LIFELINE BOW PULPIT		1
	H 28 01 07 610	DOUBLE RAIL DOUBLE LIFELINE BOW PULPIT, FOR BOW SPRIT OPTION		1
	H 28 01 01-07F	FASTENER KIT: (12) 1/4"-20 x 2 " SLOT RHMS, S.S. (12) 1/4" FLAT WASHER, S.S. (12) 1/4" LOCK WASHER, S.S. (12) 1/4"- 20 HEX NUT, S.S.		1
2	H 28 08 11 900	LIFELINE TURNBUCKLE , S.S., COMPLETE .		2
3	H 28 08 13 740	LOCK NUT FOR LIFELINE TURNBUCKLE		2
4	H 22 08 01 900	BOW PLATE W/TANG, S.S.	1	
	H 22 08 01F	FASTENER KIT: (4) 3/8"-16 x 1 1/2" RHMS, S.S. (4) 3/8" FLAT WASHER, S.S. (4) 3/8" LOCK WASHER, S.S. (4) 3/8"-16 HEX NUT, S.S. (1) 5/16"-18 x 2 " RHMS, S.S. (1) 5/16" FLAT WASHER, S.S. (1) 5/16" LOCK WASHER, S.S. (1) 5/16"-18 HEX NUT, S.S.	1	

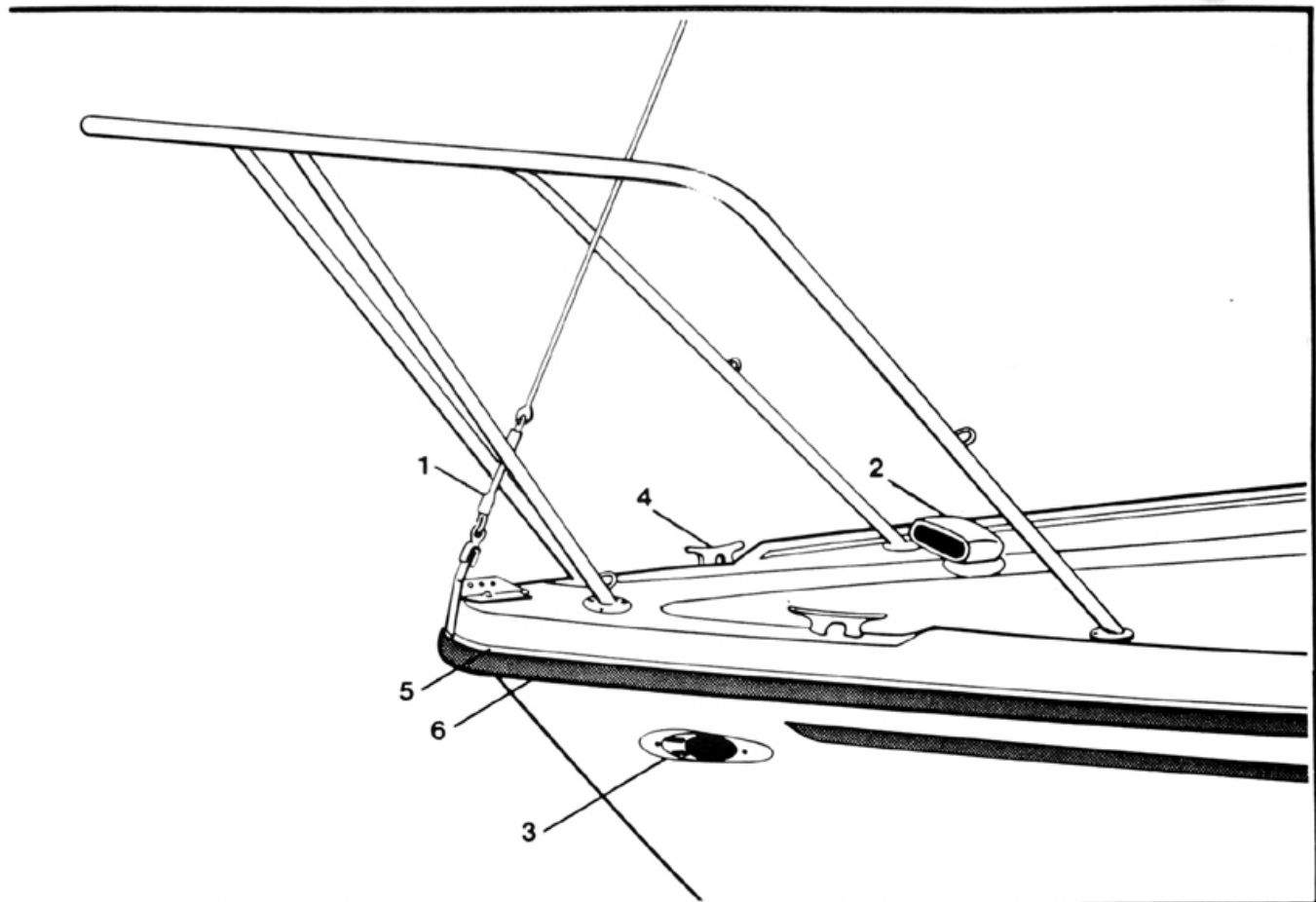

ref	Part Number	Description	std	opt
1	H 33 01 01 900	5/16"-18 TURNBUCKLE, S.S., COMPLETE	8	
	H 33 01 03 740	RIGHT HAND LOCK NUT, S.S. 5/16"-18	8	
	H 33 01 05 740	LEFT HAND LOCK NUT, S.S. 5/16"-18	8	
2	H 26 15 01 620	COWL VENT W/FLANGE AND CAP		1
	H 26 15 01 F	FASTENER KIT: (3) #8 x 3/4" PHIL. PHSMS, S.S.		1
	H 74 01 01 497	STARBOARD RUNNING LIGHT, GREEN	1	
3	H 74 01 03 497	PORT RUNNING LIGHT RED	1	
	H 74 01 01-03F	FASTENER KIT: (2) #10 x 3/4" SLOT. OHSMS, S.S.	2	
4	H 24 09 01 760	MOORING CLEAT	4	
	H 24 09 01F	FASTENER KIT: (2) 1/4"-20 x 2 1/4" SLOT. FHMS, S.S.	4	
		(2) 1/4" FLAT WASHER, S.S.		
		(2) 1/4" LOCK WASHER, S.S.		
		(2) 1/4"-20 HEX NUT, S.S.		
5	H 22 02 01 105	ALUMINUM RUB RAIL, 3 LENGTHS PER BOAT, 60'-0"	3	
	H 22 02 01F	FASTENER KIT: (60) #10 x 1" PHIL. PHSMS, S.S.	3	
		NOTE: ONE FASTENER KIT PER SECTION.		
6	H 22 03 01 036	BROWN VINYL RUB RAIL INSERT, 60'-0"	1	

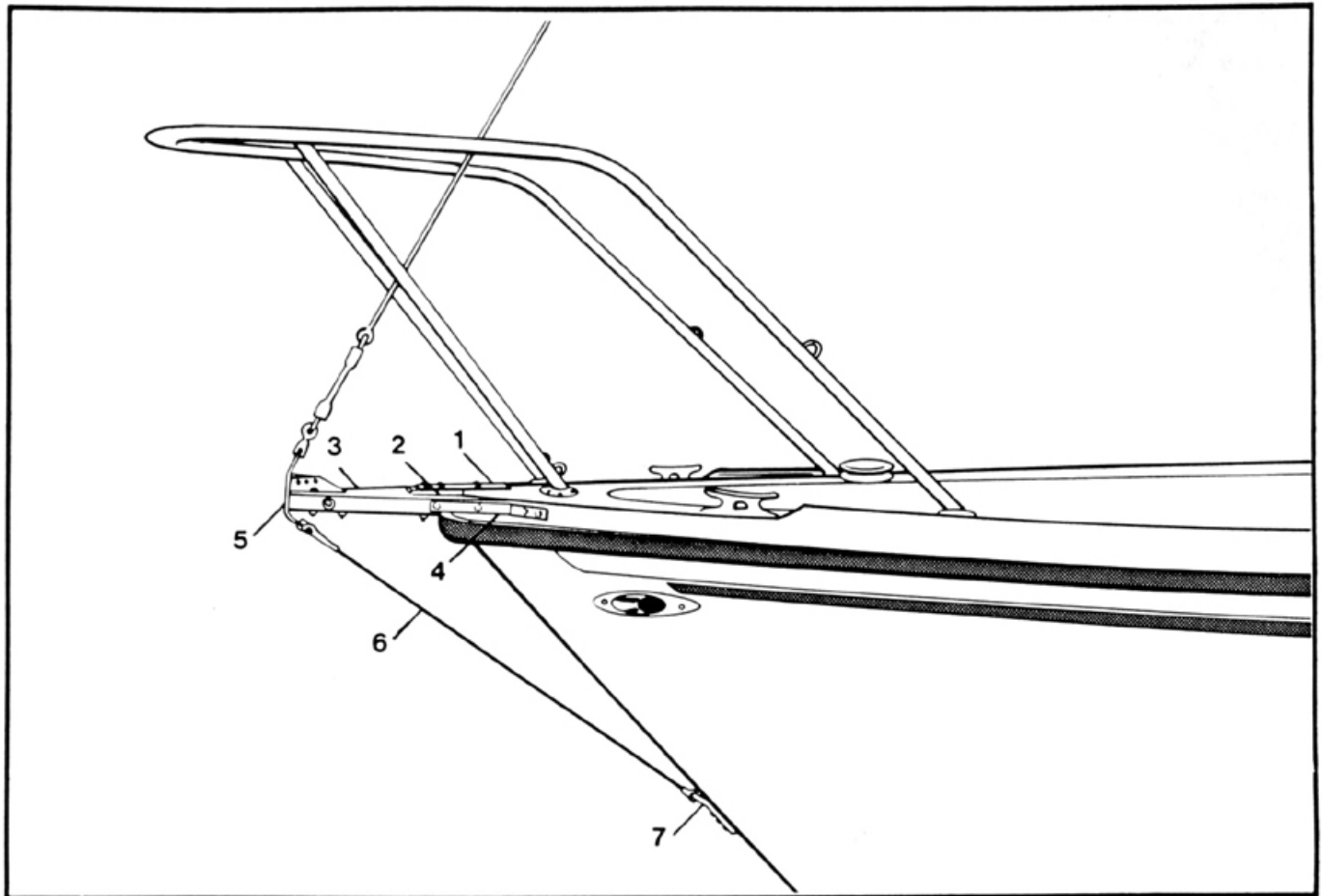

ref	Part Number	Description	std	opt
1	H 22 06 01 900	BOW SPRIT DECK PLATE, S.S.		1
2	H 22 06 03 285	BOW SPRIT SHIM, TEAK		1
3	H 22 06 05 285	BOW SPRIT, TEAK		1
	H 22 06 01-05F	FASTENER KIT: (4) 5/16"-18 x 2" SLOT. RHMS, S.S. (4) 5/16"-18 x 2 1/2" HHMB, S.S. (1) 5/16"-18 x 5" THREAD, S.S. (10) 5/16" FLAT WASHER, S.S. (10) 5/16" LOCK WASHER, S.S. (10) 5/16"-18 HEX NUT, S.S.		1
4	H 22 06 07-900	BOW SPRIT STRAP, S.S.		2
	H 22 06 07F	FASTENER KIT: (4) 5/16"-18 x 2" SLOT, RHMS, S.S. (1) 5/16"-18 x 7 1/4" THREAD, S.S. (6) 5/16" FLAT WASHER, S.S. (6) 5/16" LOCK WASHER, S.S. (6) 5/16"-18 HEX NUT, S.S. (2) #10 x 2" OHSMS, S.S. (2) #10 FINISH WASHER, S.S.		2
5	H 22 06 09 900	BOW PLATE W/TANG		1
	H 22 06 09F	FASTENER KIT: (4) 5/16"-18 x 2" SLOT. RHMS, S.S. (4) 5/16" FLAT WASHER, S.S. (4) 5/16" LOCK WASHER, S.S. (4) 5/16"-18 HEX NUT, S.S.		1
6	H 22 06 11 100	BOB STAY, 1 x 19, 3/16" x 38 1/2" LONG EYE TO EYE		1
	H 22 06 13 900	5/16" x 3/4" F.H. RIVET, S.S.		2
	H 22 06 15 740	3/32" x 1 1/2" COTTER PIN, S.S.		2
7	H 22 06 17 900	HULL TANG, S.S.		1
	H 22 06 19 900	BACK UP PLATE, S.S.		1
	H 22 06 17-19F	FASTENER KIT: (3) 3/8"-16 x 1 1/2" SLOT, RHMS, S.S. (3) 3/8" LOCK WASHER, S.S. (3) 3/8" FLAT WASHER, S.S. (3) 3/8"-16 HEX NUT, S.S.		1
	H 22 06 21 285	LINER COVER, INSIDE FOREPEAK (COVERS ACCESS HOLE IN LINER)		1
	H 22 06 21F	FASTENER KIT: (2) #10 x 1 1/4" SLOT, OHSMS, S.S. (2) #10 FINISH WASHER, S.S.		1
	H 22 06 00 100	BOW SPRIT ASSEMBLY COMPLETE		1

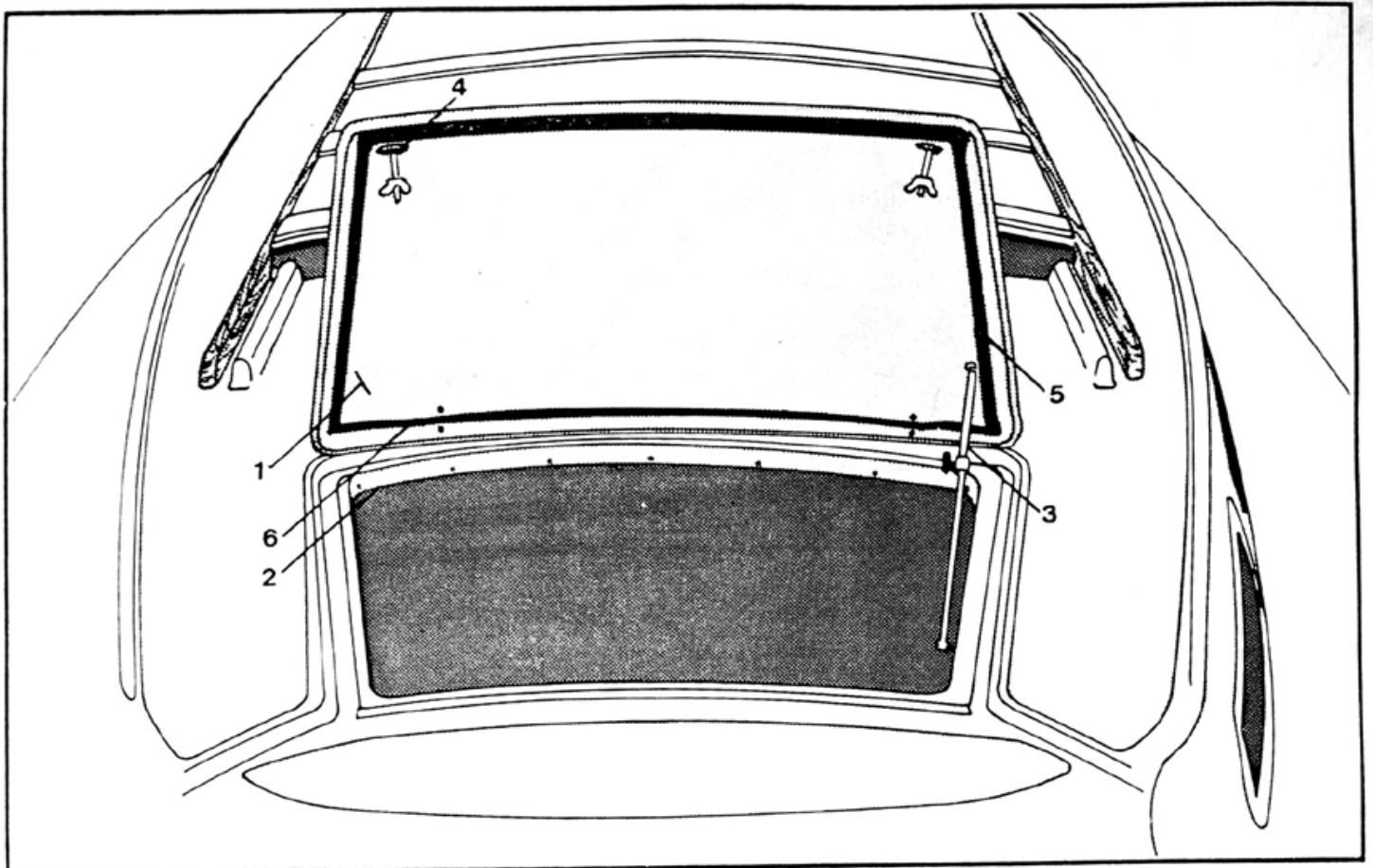

ref	Part Number	Description	std	opt
1	H 26 01 01 100	HATCH COVER, FIBERGLASS	1	
2	H 26 01 03 012	MOLDING TRIM, WHITE VINYL, 94"	1	
	H 26 01 03F	FASTENER KIT: (20) #8 x 3/4" PHIL. PHSMS, S.S.	1	
3	H 26 01 05 497	HATCH ADJUSTOR, CHROME PLATED	1	
	H 26 01 05F	FASTENER KIT: (2) #6-32 x 1" SLOT, PHSMS, S.S.	1	
		(2) #6 FLAT WASHER, S.S.		
		(2) #6 LOCK WASHER, S.S.		
		(2) #6-32 HEX NUT, S.S.		
		(2) #8 x 3/4" PHIL PHSMS, S.S.		
	26 01 07 008	HINGE, S.S.	2	
	26 01 07F	FASTENER KIT: (6) #10 x 3/4" SLOT. OHSMS, S.S.	2	
4	H 26 01 09 613	HATCH DOG, CHROME PLATED	2	
	H 26 01 09F	FASTENER KIT: (4) #6-32 x 1" SLOT. PHSMS, S.S.	2	
	H 26 01 11 493	HATCH DOG PLATE, S.S.	2	
	H 26 01 11F	FASTENER KIT: (3) #8 x 3/4" PHIL. PHSMS, S.S.	2	
5	H 26 01 13 920	GASKET TAPE, 1/2" x 1/2" x 66"	1	
6	H 26 01 15 920	GASKET TAPE, 1/2" x 1/4" x 34"	1	
	H 26 01 00 100	FORWARD HATCH ASSEMBLY, COMPLETE	1	

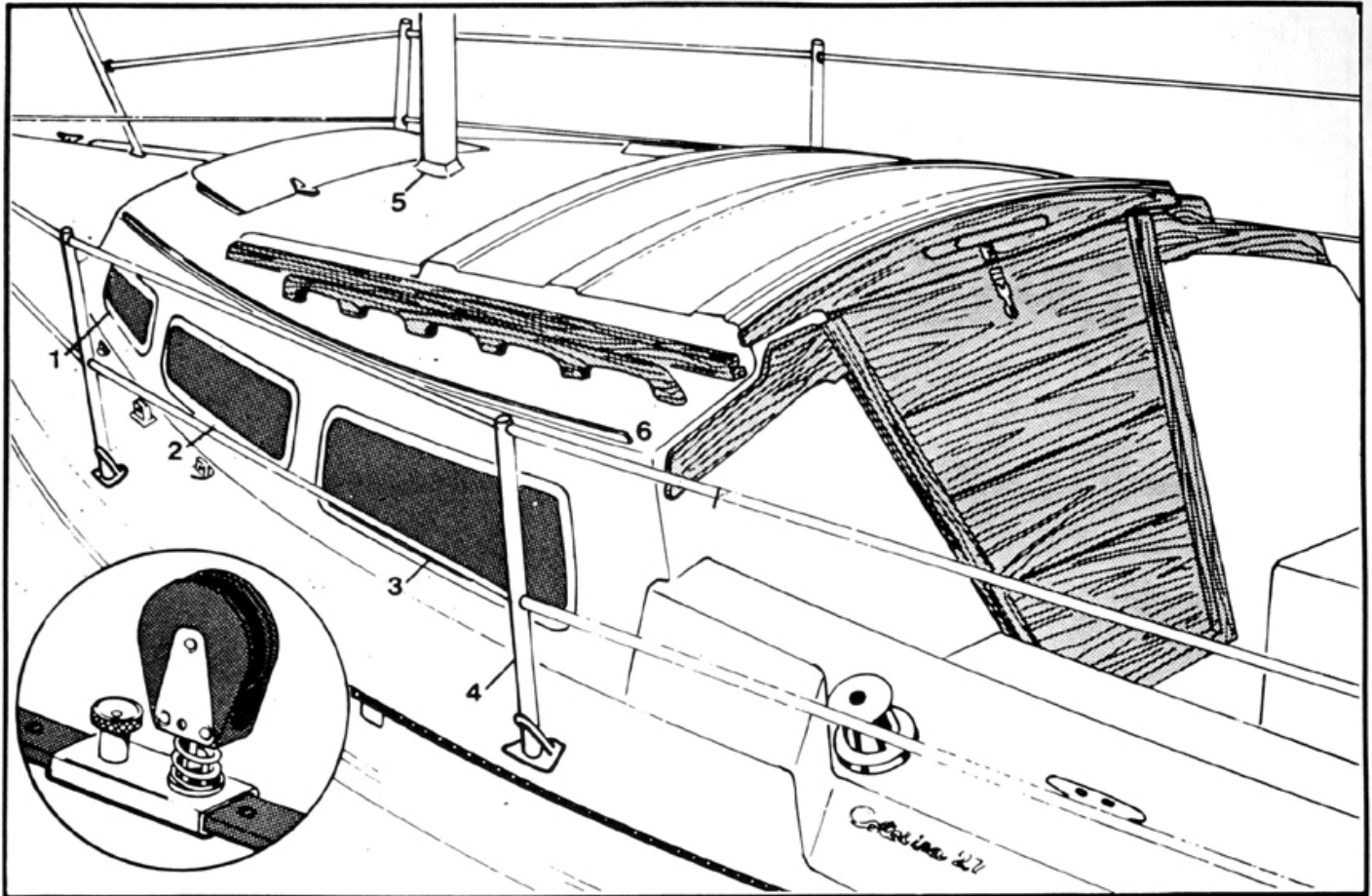

ref	Part Number	Description	std	opt
1	H 26 13 03 460	FORWARD PORT WINDOW W/FRAME	1	
	H 26 13 01 460	FORWARD STARBOARD WINDOW/FRAME	1	
2	H 26 13 01-03F	FASTENER KIT: (28) #8 x 3/4" PHIL. PHSMS, S.S.	2	
	H 26 13 07 460	MIDDLE PORT WINDOW W/FRAME	1	
	H 26 13 05 460	MIDDLE STARBOARD WINDOW W/FRAME	1	
3	H 26 13 05-07F	FASTENER KIT: (32) #8 3/4" PHIL. PHSMS, S.S.	2	
	H 26 13 11 460	AFT PORT WINDOW/FRAME	1	
	H 26 13 09 460	AFT STARBOARD WINDOW W/FRAME	1	
4	H 26 13 09-11F	FASTENER KIT: (30) #8 x 3/4" PHIL PHSMS, S.S.	2	
	H 28 05 01 610	SINGLE LIFELINE STANCHION SPECIFY 6° OR 10°	6	
	H 28 05 03 610	DOUBLE LIFELINE STANCHION SPECIFY 6° OR 10°	6	
		NOTE: 6° STANCHION IS USED FOR (1) FORWARD STANCHION ON EACH SIDE ONLY		
	H 28 05 01-03F	FASTENER KIT: (4) 1/4"-20 x 2" SLOT. RHMS, S.S. (4) 1/4" LOCK WASHER, S.S. (4) 1/4" FLAT WASHER, S.S. (4) 1/4"-20 HEX NUT, S.S.	6	
5	H 24 06 01 900	MAST STEP, ALUMINUM CASTING	1	
	H 24 06 01F	FASTENER KIT: (4) 5/16" x 1 1/4" LAG BOLT, S.S.	1	
	H 24 07 01 255	HINGED MAST STEP W/PIVOT BOLT, S.S.		1
6	H 24 07 01F	FASTENER KIT: (4) #16 x 1 1/2" SLOT. FHWS		1
	H 24 11 01 285	HANDRAIL, TEAK		2
	H 24 11 01 F	FASTENER KIT: (12) #10 x 2" SLOT. OHSMS, S.S. (12) #10 FINISH WASHER, S.S.		2

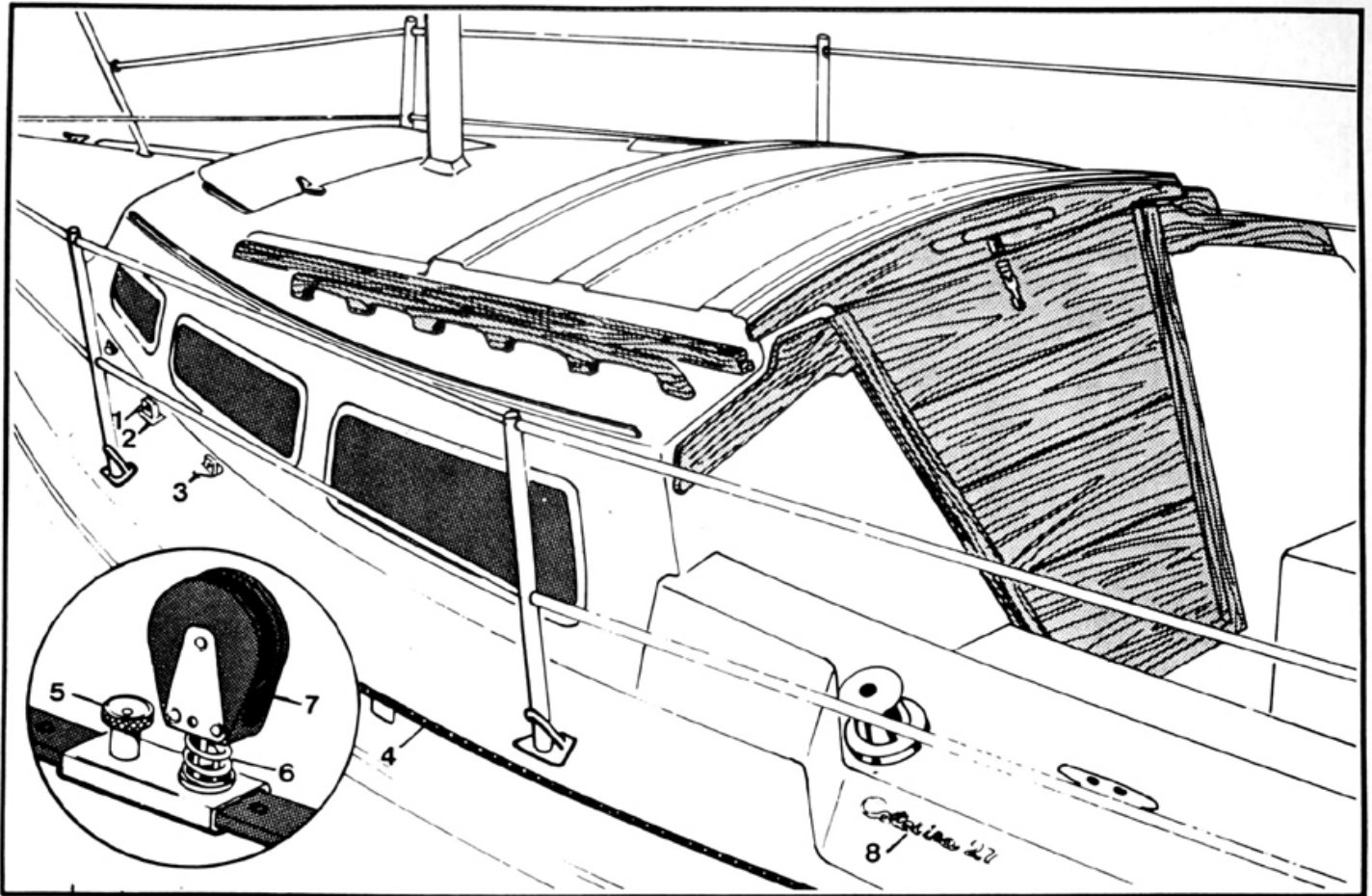

ref	Part Number	Description	std	opt
1	H 22 09 01 900 H 22 09 01F	MAIN CHAINPLATE, S.S. FASTENER KIT: (4) 3/8"-16 x 1 1/2 RHMS, S.S. (4) 3/8" FLAT WASHER, S.S. (4) 3/8" LOCK WASHER, S.S. (4) 3/8"-16 HEX NUT, S.S.	2	2
2	H 22 09 03 900 H 22 09 03F	MAIN CHAINPLATE DECK COVER, S.S. FASTENER KIT: (4) #8 x 3/4" PHIL. PHSMS, S.S.	2	2
3	H 22 10 01 512 H 22 10 03 900 H 22 10 01-03F	LOWER SHROUD 1/2- 13 x 2" CHAINPLATE EYEBOLT BACK UP PLATE, S.S. FASTENER KIT: (1) 1/2" FLAT WASHER, S.S. (1) 1/2" LOCK WASHER, S.S. (1) 1/2" -13 HEX NUT, S.S.	4	4
	H 23 01 01 900 H 23 01 01F	4'-0" JIB TRACK FASTENER KIT: (13)1/4"-20 x 3" SLOT. FHMS, S.S. (13)1/4" FLAT WASHER, S.S. (13)1/4" LOCK WASHER, S.S. (13)1/4"-20 HEX NUT, S.S. (1) #14 FINISH WASHER, S.S.	2	2
4	H 23 01 03 900 H 23 01 03F	14'-0" GENOA TRACK FASTENER KIT: (42)1/4"-20 x 3" SLOT. FHMS, S.S. (42)1/4" FLAT WASHER, S.S. (42)1/4" LOCK WASHER, S.S. (1) #14 FINISH WASHER, S.S. (42)1/4"-20 HEX NUT, S.S.	2	2
5	H 34 01 01 530	GENOA CAR	2	
6	H 34 01 05 725	STAND UP SPRING	2	
7	H 34 01 03 725	GENOA BLOCK	2	
8	H 25 06 01 047	LOGO "CATALINA 27"	2	



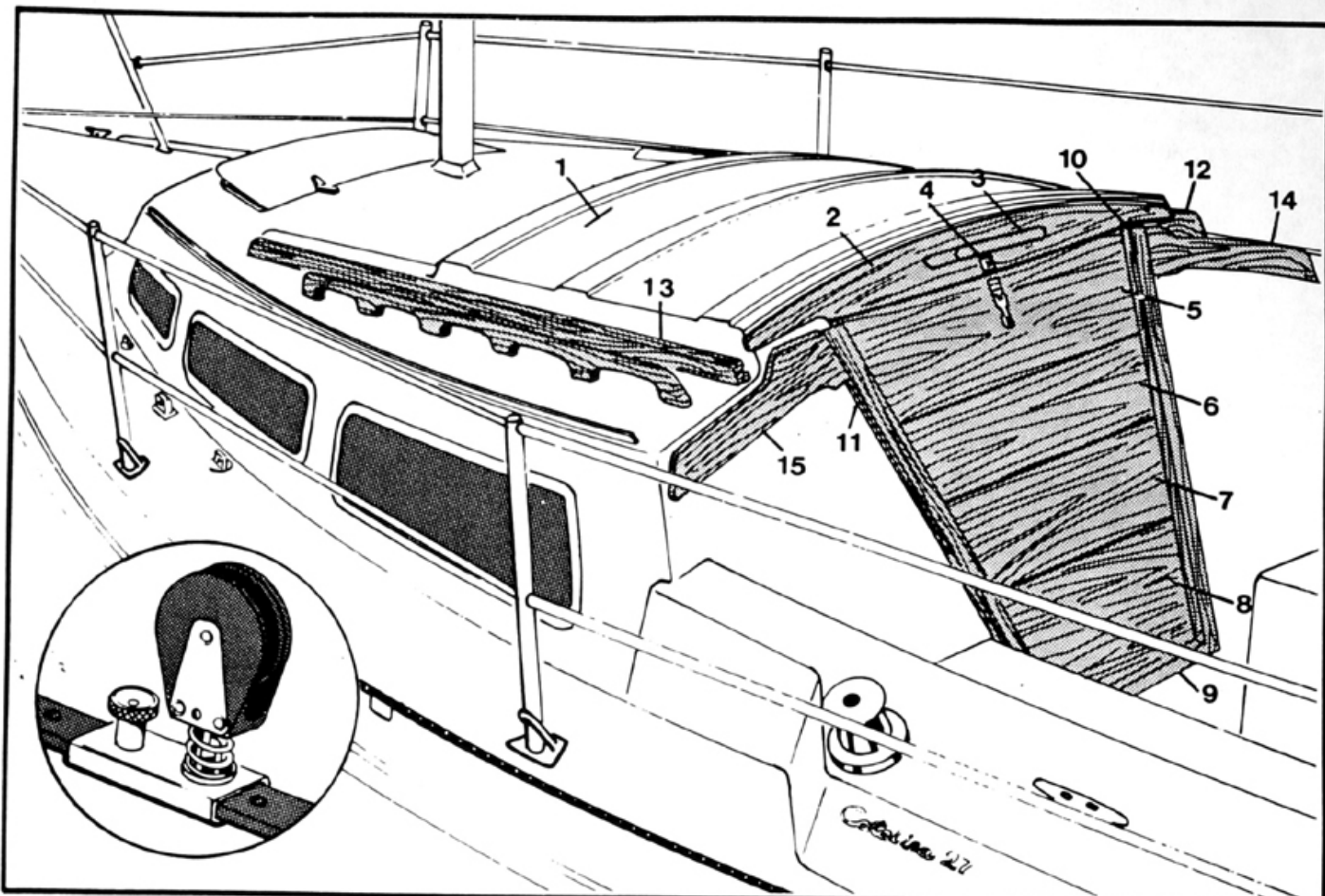

ref.	Part Number	Description	std	opt
1	H 26 03 03 100	SLIDING HATCH, FIBERGLASS	1	
	H 26 03 05 285	SLIDING HATCH TEAK TRIM (FWD)	1	
	H 26 03 05F	FASTENER KIT: (10) #8 x 3/4" PHIL. PHSMS, S.S.	1	
2	H 26 03 07 285	WEATHERBOARD	1	
	H 26 03 07F	FASTENER KIT: (12) #8 x 3/4" PHIL. PHSMS, S.S.	1	
3	H 26 03 11 285	SLIDING HATCH HANDLE, TEAK	1	
	H 26 03 11F	FASTENER KIT: (2) #10 x 1 1/2" SLOT. OHSMS, S.S. (2) #10 FINISH WASHER, S.S.	1	
4	H 26 03 09 497	HASP AND EYE, CHROME PLATED	1	
	H 26 03 09F	FASTENER KIT: (8) #6 x 3/8" PHIL. PHSMS, S.S.	1	
5	H 26 03 23 285	1st (TOP) HATCH BOARD, TEAK	1	
6	H 26 03 25 285	2ND HATCH BOARD, TEAK	1	
7	H 26 03 27 285	3RD HATCH BOARD, TEAK	1	
8	H 26 03 29 285	4TH (BOTTOM) HATCH BOARD, TEAK	1	
9	H 26 03 31 285	EXTERIOR THRESHOLD, TEAK:	1	
	H 26 03 31F	FASTENER KIT: (3) #10 x 1 1/2" SLOT. OHSMS, S.S.	1	
	H 26 03 33 285	INTERIOR THRESHOLD, TEAK	1	
	H 26 03 31-33F	FASTENER KIT: (4) #10 x 2" SLOT. OHSMS, S.S.	1	
10	H 26 03 35 285	STARBOARD, EXTERIOR COMPANIONWAY TRIM, TEAK	1	
11	H 26 03 37 285	PORT EXTERIOR COMPANIONWAY TRIM, TEAK	1	
	H 26 03 35-37F	FASTENER KIT: (5) #10 x 2" SLOT. OHSMS, S.S.	2	
12	H 26 03 43 285	STARBOARD RAILWOOD, TEAK	1	
13	H 26 03 45 285	PORT RAILWOOD, TEAK	1	
	H 26 03 43-43F	FASTENER KIT: (8) #10 x 2" SLOT. OHSMS, S.S. (8) #10 FINISH WASHER, S.S.	2	
14	H 26 03 47 285	STARBOARD CABIN TRIM, TEAK	1	
15	H 26 03 49 285	PORT CABIN TRIM, TEAK	1	
	H 26 03 47-49F	FASTENER KIT: (6) #10 x 1" SLOT. OHSMS, S.S.	2	

**Catalina 27**

**PARTS  
CATALOGUE**

MIDSHIP  
MAIN HATCH ASSEMBLY

7

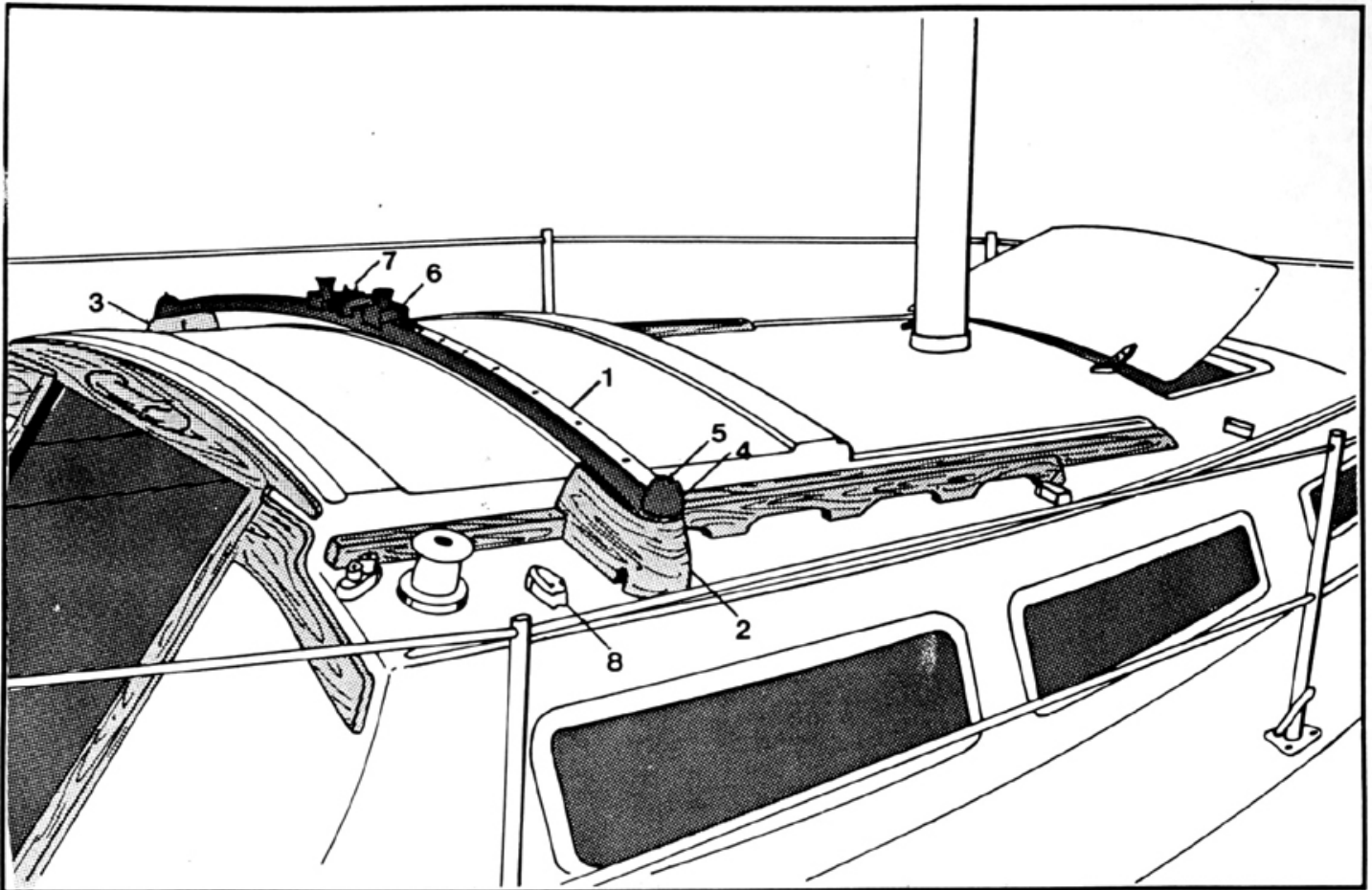

ref	Part Number	Description	std	opt
1	H 23 02 01 530	MIDSHIP TRAVELER TRACK		1
2	H 23 02 03 285	STARBOARD HORSE BLOCK		1
3	H 23 02 05 285	PORT HORSE BLOCK		1
	H 23 02 03-05F	FASTENER KIT: (3) 1/4"-20 x 8" SLOT. FHMS, S.S. (3) 1/4" FLAT WASHER, S.S. (3) 1/4" LOCK WASHER, S.S. (3) 1/4"-20 HEX NUT, S.S. (3) 1/4"-20 CAP HEX NUT, S.S.		2
4	H 23 02 07 530	END STOP, BLACK RUBBER		2
5	H 23 02 09 530	PIN, FOR END STOP, S.S.		2
6	H 23 02 11 530	ADJUSTABLE STOP		2
7	H 23 02 15 530	ROLLER TRAVELER CAR W/SHACKLE		1
8	H 23 02 17 725	CHEEK BLOCK		3
	H 23 02 17F	FASTENER KIT: (3) #10 -24 x 3 1/2" SLOT. FHMS, S.S. (3) #10 FINISH WASHER, S.S. (3) #10 FLAT WASHER, S.S. (3) #10 LOCK WASHER, S.S. (3) #10-24 HEX NUT, S.S. (3) #10-24 HEX CAP NUT, S.S.		3



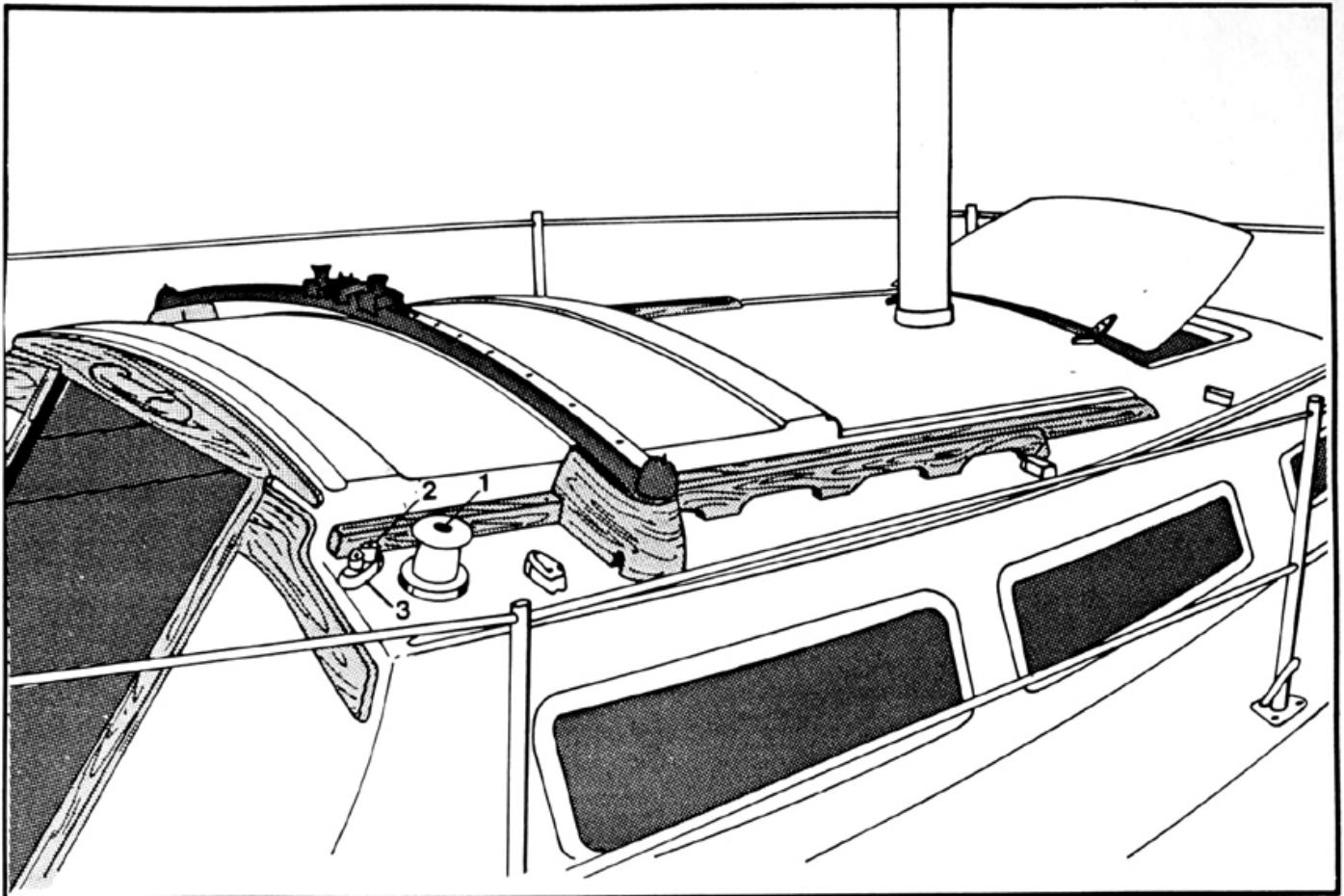

ref	Part Number	Description	std	opt
1	H 23 02 19 478	MIDSHIP TRAVELER WINCH		1
	H 23 02 19F	FASTENER KIT: (4) 1/4"-20 x 2 1/4" SLOT. RHMS, S.S.		1
		(4) 1/4" FLAT WASHER, S.S.		
		(4) 1/4" LOCK WASHER, S.S.		
		(4) 1/4"-20 HEX NUT, S.S.		
		(4) 1/4"-20 HEX CAP NUT, S.S.		
	H 23 02 21 478	WINCH HANDLE, FOR MIDSHIP TRAVELER WINCH		1
2	H 23 02 23 255	MIDSHIP TRAVELER CAM CLEAT, S.S.		1
3	H 23 02 25 285	TEAK PAD		1
	H 23 02 23-25F	FASTENER KIT: (1) #10 x 2" SLOT. OHSMS, S.S.		1
		(1) #10-24 x 3 1/2" SLOT FHMS, S.S.		
		(2) #10 FINISH WASHER, S.S.		
		(1) #10 LOCK WASHER, S.S.		
		(1) #10-24 HEX NUT, S.S.		
		(1) #10-24 HEX CAP NUT, S.S.		
	H 23 02 00 100	MIDSHIP TRAVELER ASSEMBLY, COMPLETE		1

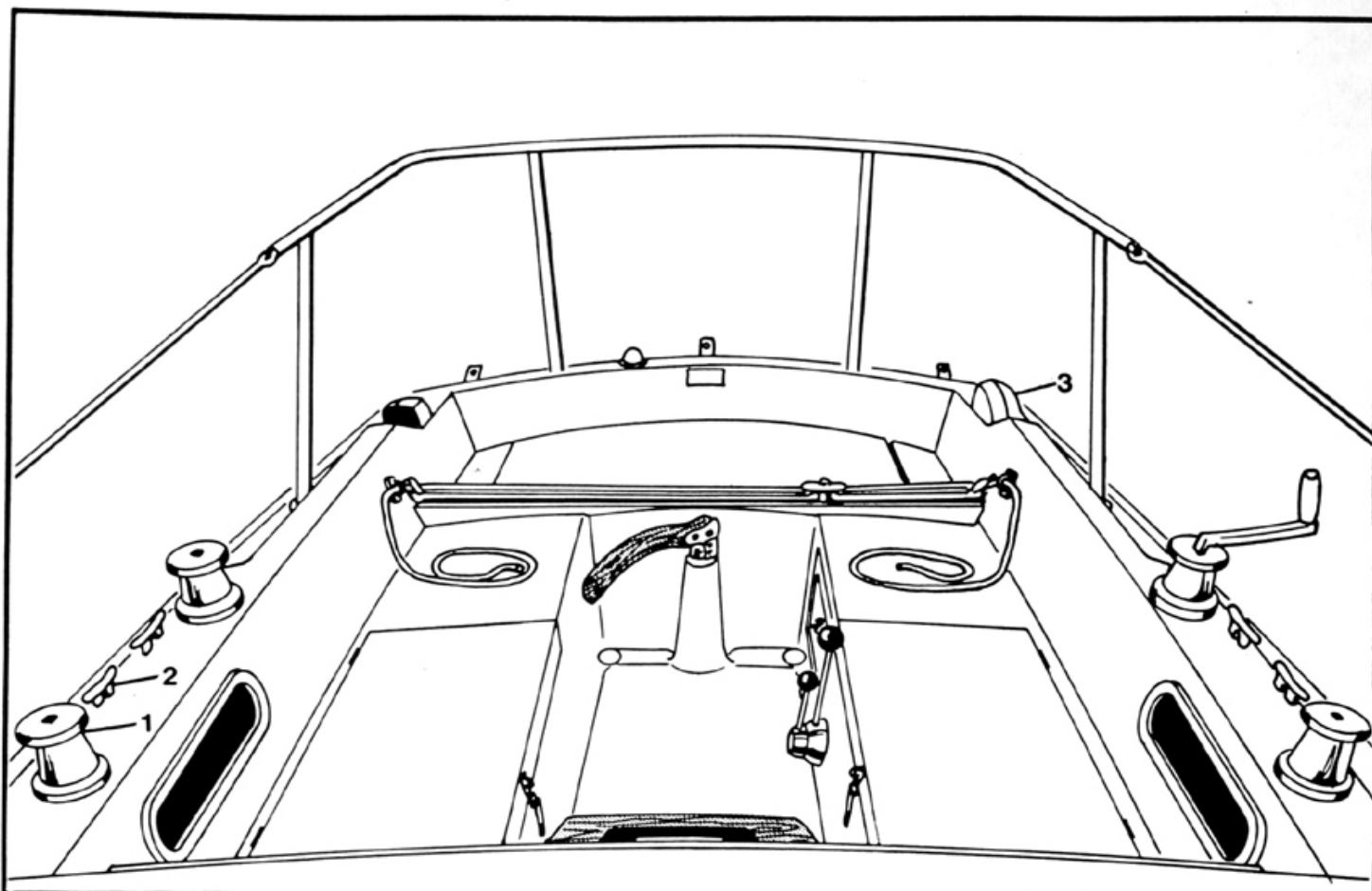

ref	Part Number	Description	std	opt
1	H 24 03 01 478	#1 JIB SHEET WINCH, SINGLE SPEED	2	
	H 24 03 02 478	#2 JIB SHEET WINCH, TWO SPEED		2
	H 24 03 01-02F	FASTENER KIT: (4) 1/4"-20 x 2" SLOT. RHMS, S.S. (4) 1/4" FLAT WASHER, S.S. (4) 1/4" LOCK WASHER, S.S. (4) 1/4"-20 HEX NUT, S.S.	2	2
	H 24 03 03 478	WINCH HANDLE, FOR SHEET WINCHES		1
2	H 24 01 01 760	JIB SHEET JAM CLEAT		2
	H 24 01 01F	FASTENER KIT: (2) 1/4"-20 x 2" SLOT. FHMS, S.S. (2) 1/4" FLAT WASHER, S.S. (2) 1/4" LOCK WASHER, S.S. (2) 1/4"-20 HEX NUT, S.S.		2
3	H 50 03 01 260	ENGINE COMPARTMENT VENT, S.S.	2	
	H 50 03 01F	FASTENER KIT: (3) #8 x 3/4" PHIL PHSMS, S.S.	2	
	H 50 03 03 519	#52 HOSE CLAMP		2
	H 50 03 05 480	VENT HOSE, WIRE REINFORCED, 3" I.D. x 30" FOR OUTBOARD ENGINE		1
	H 60 01 01 723	BILGE PUMP W/HANDLE		1
	H 60 01 01F	FASTENER KIT: (4) 1/4"-20 x 2" SLOT. RHMS, S.S. (4) 1/4"-20 HEX NUT, S.S.		1
	H 60 01 03 335	BILGE PUMP HOSE, 1" I.D. x 7'-0"		1
	H 60 01 05 519	#20 HOSE CLAMP, S.S.		3
	H 60 01 07 280	1" x CLOSE NIPPLE		1
	H 60 01 09 731	1" x 3/4" BELL REDUCER		1
	H 60 01 11 280	3/4" x 1 3/4" HALF THREADED NIPPLE		1
	H 60 01 13 519	#8 HOSE CLAMP		1
	H 60 01 17 035	BILGE PUMP HOSE, 3/4" I.D. x 8'-10", CLEAR VINYL		1
	H 60 01 19 140	THRU HULL, FOR INBOARD ENGINE ONLY		1
	H 60 01 00 100	BILGE PUMP ASSEMBLY, COMPLETE		1

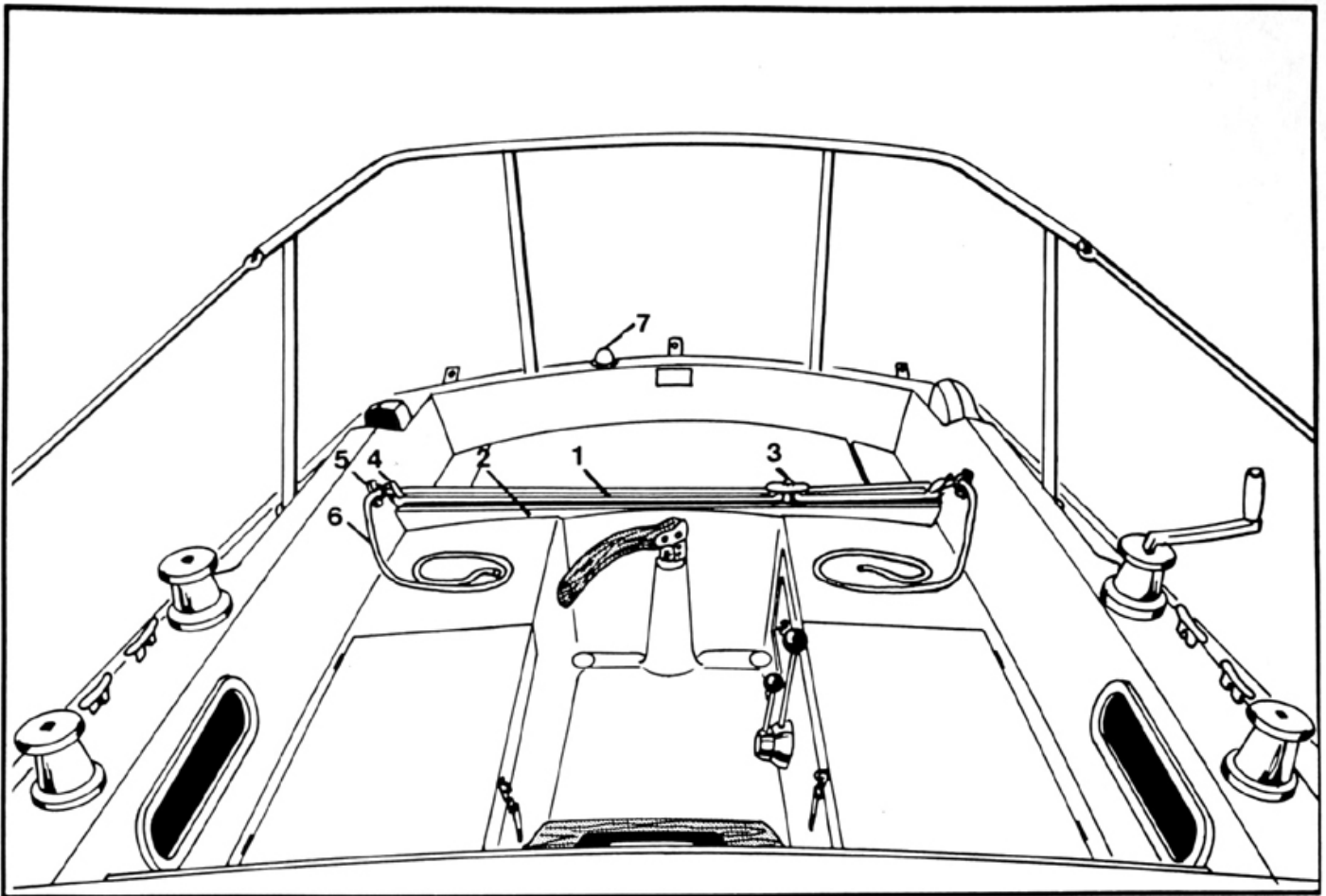

ref	Part Number	Description	std	opt
1	H 23 05 01 715	DELUXE AFT TRAVELER EXTRUSION - 4'-0"		1
2	H 23 05 03 285	DELUXE TRAVELER BACKING, TEAK		2
	H 23 05 01 03F	FASTENER KIT: (12) #10-24 x 3 1/2" SLOT. FHMS, S.S. (12) #10 FLAT WASHER, S.S. (12) #10 LOCK WASHER, S.S. (12) #10-24 HEX NUT, S.S.		1
	H 23 05 05 715	END STOP, BLACK PLASTIC		2
	H 23 05 05F	FASTENER KIT: (1) #10 x 1/4" SLOT. OHSMS, S.S.		2
3	H 23 05 09 715	ROLLER TRAVELER CAR W/SHEAVES		1
4	H 23 05 11 725	SINGLE BLOCK W/BECKET		2
	H 23 05 13 255	PAD EYE, S.S.		2
	H 23 05 13F	FASTENER KIT: (2) #10-24 x 1" SLOT. RHMS, S.S. (2) #10 FLAT WASHER, S.S. (2) #10 LOCK WASHER, S.S. (2) #10-24 HEX NUT, S.S.		2
5	H 23 05 15 715	CAM CLEAT W/FAILEAD		2
	H 23 05 15F	FASTENER KIT: (2) #10-24 x 1" SLOT. RHMS, S.S. (2) #10 FLAT WASHER, S.S. (2) #10 LOCK WASHER, S.S. (2) #10-24 HEX NUT, S.S.		2
6	H 23 05 17 275	ADJUSTER LINE, BRAIDED DACRON, 1/4" x 10'-0"		2
	H 23 05 00 100	DELUXE AFT TRAVELER ASSEMBLY, COMPLETE		1
7	H 75 03 01 497	WHITE, 12 POINT STERN LIGHT	1	

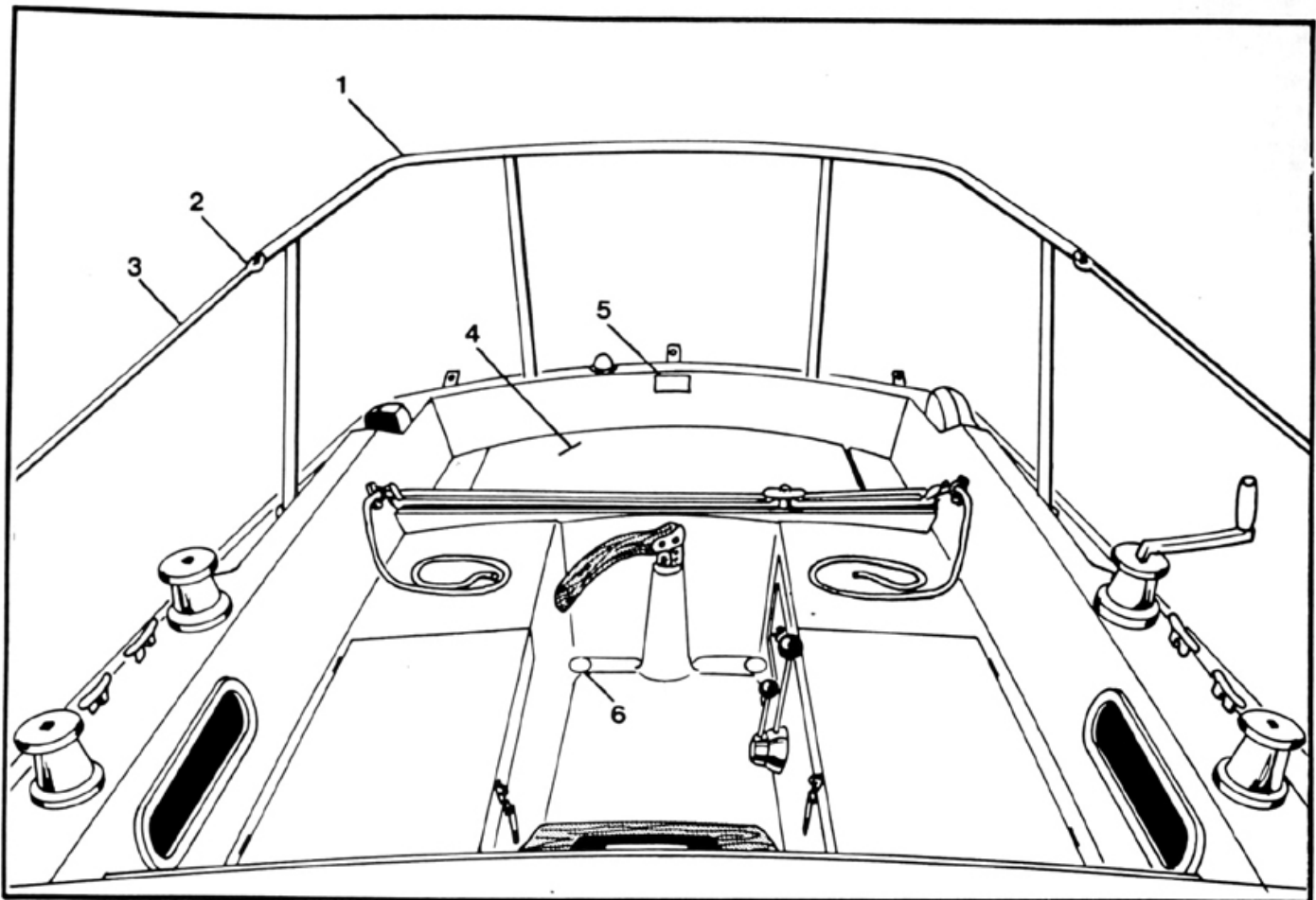

ref.	Part Number	Description	std	opt
1	H 28 03 01 610	SINGLE LIFELINE SINGLE RAIL STERN PULPIT, S.S.		1
	H 28 03 03 610	DOUBLE LIFELINE DOUBLE RAIL STERN PULPIT, S.S.		1
	H 28 03 04 900	STERN PULPIT BACK UP PLATE, BRASS	2	
	H 28 03 01-04F	FASTENER KIT: (6) 1/4"-20 x 2" SLOT. RHMS, S.S. (10) 1/4" FLAT WASHER, S.S. (10) 1/4" LOCK WASHER, S.S. (4) 1/4"-20 x 3/4" SLOT. RHMS, S.S. (10) 1/4"-20 HEX NUT, S.S.		2
2	H 28 07 09-500	PELICAN HOOK		2
3	H 28 07 01 100	SINGLE LIFELINE, FOR SINGLE RAIL PULPITS		2
	H 28 07 03 100	UPPER LIFELINE, FOR DOUBLE RAIL PULPITS		2
	H 28 07 05 100	LOWER LIFELINE, FOR DOUBLE RAIL PULPITS		2
4	H 26 09 01 100	LAZARETTE SEAT HATCH, FIBERGLASS	1	
	H 26 09 03 049	HINGE	2	
	H 26 09 03F	FASTENER KIT: (4) #6-32 x 1" SLOT. FHMS, S.S. (4) #6 FLAT WASHER, S.S. (4) #6 LOCK WASHER, S.S. (4) #6-32 HEX NUT, S.S.		2
	H 26 09 05 920	GASKET TAPE, 1/4" x 3/4" x 39"	1	
	H 26 09 07 255	PAD EYE, S.S.	1	
	H 26 09 07F	FASTENER KIT: (2) #6 x 3/8" PHIL. OHSMS, S.S.	1	
	H 26 09 09 275	LANYARD, BRAIDED DACRON, 3/16" x 36"	1	
5	H 25 02 01 737	HULL IDENTIFICATION PLATE, S.S.	1	
	H 25 02 01F	FASTENER KIT: (2) #10 x 3/4" SLOT. PHSMS, S.S.	1	
6	H 61 01 01 282	COCKPIT SCUPPER SCREEN	2	
	H 61 01 03 909	3/8" DRAIN TUBE		2